

Appendix — dataTaker DT53

Introduction

Each model in the **dataTaker** data logger range has a number of characteristics that differentiate it from the other models. This Appendix describes these characteristics for the **dataTaker 53**.

Digital Inputs and Outputs

- 4 TTL/CMOS compatible digital input channels for digital state, digital events, low speed counters (10 Hz, 16 bit, presettable).
- Digital input terminals are shared with digital output channels
- 4 Digital open collector outputs rated to 200mA at 30V
- 3 high speed counters, (1KHz or 1MHz, 16 bit, presettable).

Input Type	Channels	Range
Digital Bit	4	0 or 1 State
Digital Nibble	1	0 to 16 State
LS counter	4	65535 Counts
HS counter	3	65535 Counts

Power Supply and Battery

The **dataTaker 53** can be powered as follows

Source	Range	+ Terminal	- Terminal
AC	9 – 18Vac	AC/DC~	AC/DC~
DC	11 – 24Vdc	AC/DC~	AC/DC~
DC	11 – 24Vdc	AC/DC~	Gnd
9V Alkaline Battery	6.2 – 10Vdc	Alkaline +	Bat. -
6V Gel Cell Battery	5.6 – 8Vdc	Lead +	Bat. -

The external 6 Volt gel cell connection provides temperature compensated charging with voltage (6.90V) and current (1A) limiting for a three cell battery, when an external AC or DC power supply is also connected.

When the **dataTaker 53** is powered by a 9V alkaline battery and an external AC or DC source, the 6.9V regulator's (see schematic) output is increased to 10V so that power is drawn from the external source in preference to the battery.

Caution - To avoid damage use 6 Volt lead acid battery only, ensure correct polarity before connecting the battery

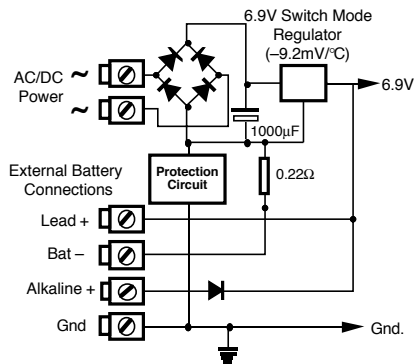

Simplified Power Supply Schematic

COMMS Port

also page 13
The **dataTaker 53** RS232 COMMS Port is serial RS232 compatible. The output signal level is approximately ±4 Volts, allowing communications over distances in excess 100 meters at 1200 baud. Greater distances are possible at 300 baud. The maximum practical distance is also dependent on the host computer's RS232 characteristics. (Note: the RS232 "standard" specifies 2000pF maximum cable capacitance, and no maximum distance).

The **dataTaker 53** RS232 COMMS Port is electrically isolated to 500V.

RS232 COMMS

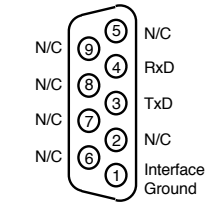

Dip Switch

Shown set to the factory defaults

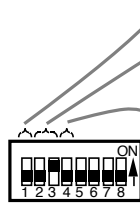

Country	s1
US (60Hz)	on
Other (50Hz)	off

Baud Rate	s2	s3	s5	Add. Range
1200	off	off	x	0 - 15
9600	off	on	off	0 - 7
300	off	on	on	0 - 7
2400	on	off	x	0 - 15
4800	on	on	x	0 - 15

x = don't care

Baud Rate and Address

The **dataTaker 53** RS232 COMMS port baud rate must match that of the host computer. See "COMMS Port" on page 13. If either 300 or 9600 baud is selected, the logger address range is reduced to 0 - 7.

Reserved - leave off

Address	s5	s6	s7	s8
0	off	off	off	off
1	off	off	off	on
2	off	off	on	off
3	off	off	on	on
4	off	on	off	off
5	off	on	off	on
6	off	on	on	off
7	off	on	on	on
8	on	off	off	off
9	on	off	off	on
10	on	off	on	off
11	on	off	on	on
12	on	on	off	off
13	on	on	off	on
14	on	on	on	off
15	on	on	on	on

dataTaker 53 Address

The **dataTaker 53** can be given an address, despite the fact that the logger does not support networking.

The address of a **dataTaker 53** can be used for

◆ identification in the **STATUS** or **STATUS1** commands (see "STATUS" on page 10)

◆ identification of returned data if /L Address Switch is enabled (see "Switches - /L" on page 11)

If 300 or 9600 baud rate is selected, then the address range is limited to 0 - 7.

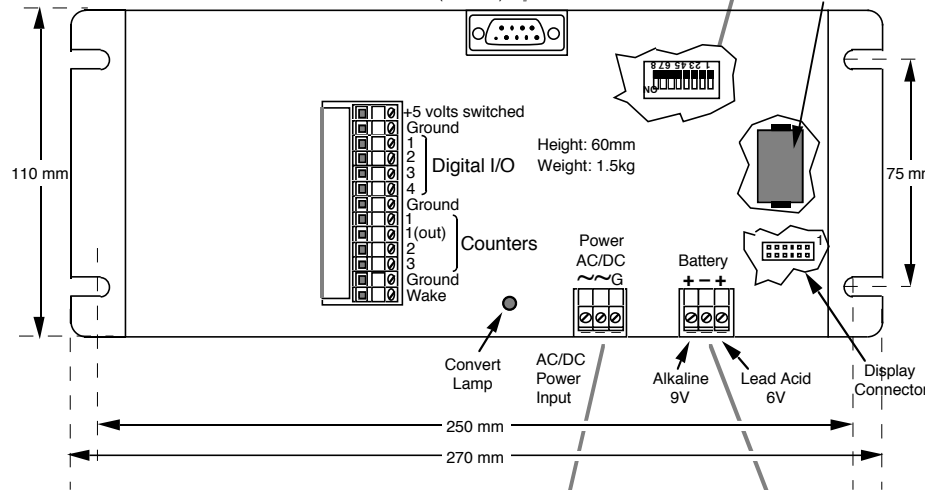

Power Consumption

The **dataTaker 53** will consume very little power if it is allowed to sleep. Less power is consumed if the **dataTaker 53** is powered through the battery terminals, rather than through the AC/DC terminals, because the battery charger circuit draws additional current, especially if it is charging a depleted battery.

Power Source	Condition	Current (typical)
battery	awake	75mA
	sleep	0.17mA
AC/DC	awake	80mA
	awake & charging	600mA
AC/DC	sleep	5mA
	sleep & charging	500mA

Wiring Power

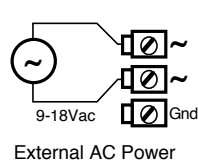

External AC Power

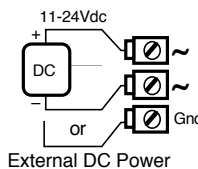

External DC Power

Wiring Battery

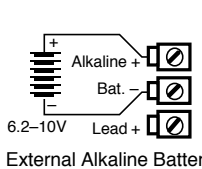

External Alkaline Battery

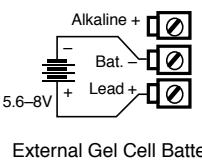

External Gel Cell Battery